

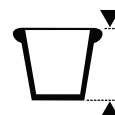

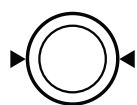

PILONE TONDO ALTO

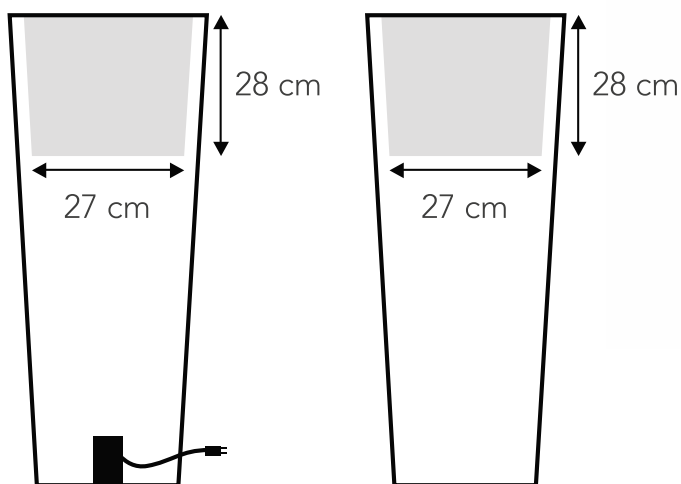
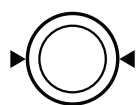
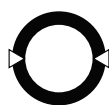

CODICE

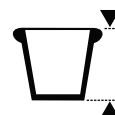
					
EPTO 100	42	34	28	93	LCR 30
EPTW 100*	42	34	28	93	-

* DOTATI DI IMPIANTO ILLUMINAZIONE / EQUIPPED WITH LIGHTING SYSTEM

 **MADE IN ITALY**

 **ECOLOGICI: ATOSSICI E RICICLABILI**
Ecological: non-toxic and recyclable

 **LEGERI**
lightweight

 **FACILMENTE LAVABILI**
Easy to wash

 **COLORI INALTERABILE U.V.**
resistant

 **ANTIMUFFA**
anti-mold

 **RESISTENTI AL GELO E AL SOLLEONE**
Warm and cold resistant

 **RESISTENTI AGLI URTI**
unbreakable